

Diagnose – EKG – 10-adrige EKG-Komplettkabel
Diagnostic – ECG – 10 lead ECG complete cable

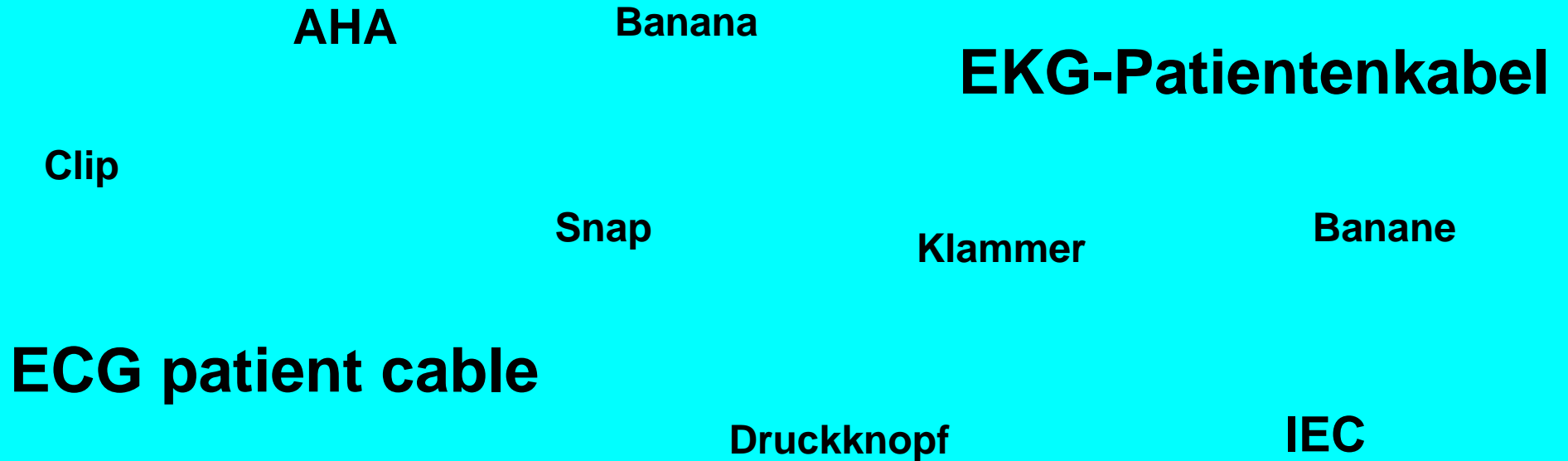

Das Qualitätsprogramm für die MEDIZINTECHNIK
The quality program for MEDICAL TECHNOLOGY

Diagnose – EKG – 10 adrige EKG-Komplettkabel Diagnostic – ECG – 10 lead ECG complete cable



Farbcode / Colour code

**Farbcode IEC mit Bananenstecker 4 mm = DIA-XXXXXX.3
Colour code IEC with 4 mm banana plug = DIA-XXXXXX.3**

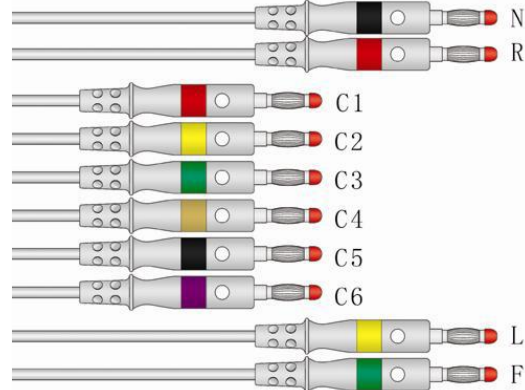

**Farbcode IEC mit Klammer 4 mm = DIA-XXXXXX.2
Colour code IEC with clip = DIA-XXXXXX.2**

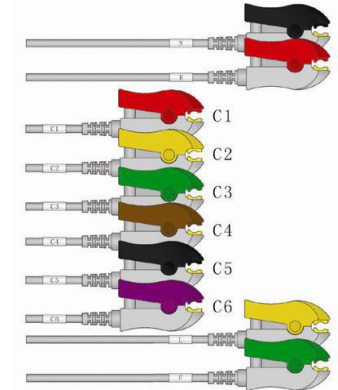

**Farbcode IEC mit Druckknopf 4 mm = DIA-XXXXXX.1
Colour code IEC with snap = DIA-XXXXXX.1**

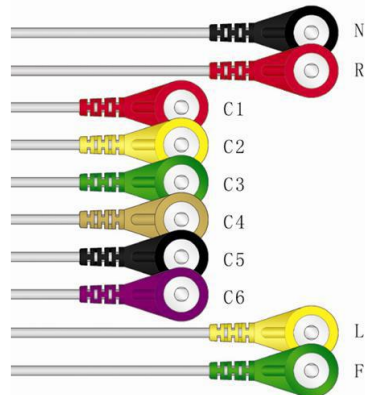

**Farbcode AHA auf Anfrage
Colour code AHA on request**

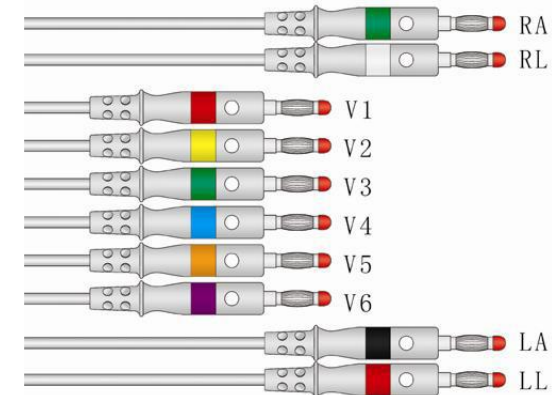

Diagnose – EKG – 10 adrige EKG-Komplettkabel Diagnostic – ECG – 10 lead ECG complete cable



Komplettkabel – Complete cable

Abbildung Art.Nr. DIA-601126.3 (4mm Bananenstecker)
Picture REF DIA-601126.3 (4 mm banana plug)



Abbildung Art.Nr. DIA-191126.1 (Druckknopf)
Picture REF DIA-191126.1 (Snap)





Abbildung Art.Nr. DIA-401060.2 (Klammer)
Picture REF DIA-401060.2 (Clip)



**Stammkabel Länge 210 cm; 10 x Einzelleitungen (Farbcode IEC); 4 x Extremitätenableitungen Länge 110 cm; 6 x Brustwandableitungen Länge 80 cm
Trunkcable length 210 cm; 10 x leadwires (Colour code IEC); 4 x limb leads length 110 cm; 6 x chest leads length 80 cm**

Diagnose – EKG – 10 adrige EKG-Komplettkabel Diagnostic – ECG – 10 lead ECG complete cable

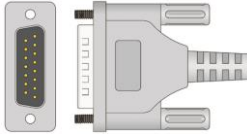
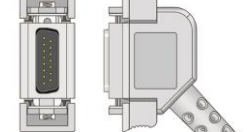
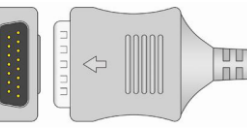
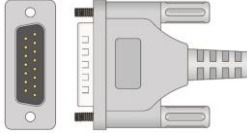

Hersteller Manufacturer	EKG-Gerätetyp ECG Device Type	Leitungen Leads	Komplettkabel Complete Cable Art.Nr. - REF	Stecker plug	Geräte-Stecker Device Connector
Amedtec	ECGpro PC-EKG, Cardiopart 12	10-adrig 10-lead	DIA-601126.3 DIA-601126.2 DIA-601126.1	4 mm Banane Klammer / Clip Druckknopf / Snap	
Avionics / Del Mar	910, 920, 930, 940, 942, 950, 960, 970, 980	10-adrig 10-lead	DIA-601126.3 DIA-601126.2 DIA-601126.1	4 mm Banane Klammer / Clip Druckknopf / Snap	
Bionet	Cardio Care 2000, Cardio 7, Bionet 7, Cardio Touch 3000 u.a./ and others	10-adrig 10-lead	DIA-601126.3 DIA-601126.2 DIA-601126.1	4 mm Banane Klammer / Clip Druckknopf / Snap	
Bosch / Dimeq	603D / 603ER / 603S / 606	10-adrig 10-lead	DIA-401060.3 DIA-401060.2 DIA-401060.1	4 mm Banane Klammer / Clip Druckknopf / Snap	
Bosch / Dimeq	EK 501, 501 A, 501 NV, 503, 503 B, 503 D, 503 NV, 503 V, 506, 506 D, 601	10-adrig 10-lead	DIA-701285.3 DIA-701285.2 DIA-701285.1	4 mm Banane Klammer / Clip Druckknopf / Snap	
BTL	BTL-08, LC plus, SD 3, MT plus	10-adrig 10-lead	DIA-601126.3 DIA-601126.2 DIA-601126.1	4 mm Banane Klammer / Clip Druckknopf / Snap	

Diagnose – EKG – 10 adrige EKG-Komplettkabel Diagnostic – ECG – 10 lead ECG complete cable

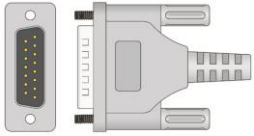
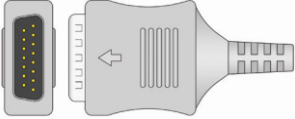
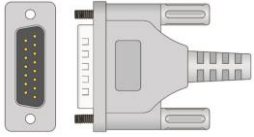
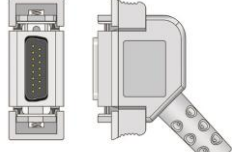
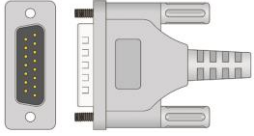
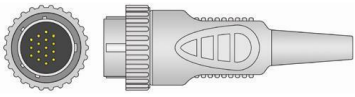

Hersteller Manufacturer	EKG-Gerätetyp ECG Device Type	Leitungen Leads	Komplettkabel Complete Cable Art.Nr. - REF	Stecker plug	Geräte-Stecker Device Connector
BTL	BTL-08, LC plus, SD 3, MT plus	10-adrig 10-lead	DIA-701252.3 DIA-701252.2 DIA-701252.1	4 mm Banane Klammer / Clip Druckknopf / Snap	
Burdick	E 350, E 550, E 560, EK 10, ELITE, ELITE II	10-adrig 10-lead	DIA-701285.3 DIA-701285.2 DIA-701285.1	4 mm Banane Klammer / Clip Druckknopf / Snap	
Burdick	ECLIPSE LE/Lei (ab/from S/N 1051), Burdick REF 007705	10-adrig 10-lead	DIA-701263.3 DIA-701263.2 DIA-701263.1	4 mm Banane Klammer / Clip Druckknopf / Snap	
Cambridge	CM 6000, CM 6400 ECG	10-adrig 10-lead	DIA-401060.3 DIA-401060.2 DIA-401060.1	4 mm Banane Klammer / Clip Druckknopf / Snap	
Cambridge	ECG 600G, ECG-1200G	10-adrig 10-lead	DIA-601126.3 DIA-601126.2 DIA-601126.1	4 mm Banane Klammer / Clip Druckknopf / Snap	
Cardioline	Delta 1, 3, 30, 60 Delta 1 Plus, Delta 3 Plus Delta 60 Plus, ELAN	10-adrig 10-lead	DIA-801494.3 DIA-801494.2 DIA-801494.1	4 mm Banane Klammer / Clip Druckknopf / Snap	

Diagnose – EKG – 10 adrige EKG-Komplettkabel Diagnostic – ECG – 10 lead ECG complete cable



Hersteller Manufacturer	EKG-Gerätetyp ECG Device Type	Leitungen Leads	Komplettkabel Complete Cable Art.Nr. - REF	Stecker plug	Geräte-Stecker Device Connector
Cardioline	alle Cardiette Typen all Cardiette types, EKG 100L EKG 100S, EKG 100+, EKG 200S, EKG 200+	10-adrig 10-lead	DIA-601126.3 DIA-601126.2 DIA-601126.1	4 mm Banane Klammer / Clip Druckknopf / Snap	
Cardioline	E 1, 1 R/3, Delta 300/360	10-adrig 10-lead	DIA-701285.3 DIA-701285.2 DIA-701285.1	4 mm Banane Klammer / Clip Druckknopf / Snap	
Cardionics	Ale EKG Typen, All ECG Types	10-adrig 10-lead	DIA-701285.3 DIA-701285.2 DIA-701285.1	4 mm Banane Klammer / Clip Druckknopf / Snap	
Cardiorapid	K-11, K-111, K-112, K-131, K-31, K-33, K-36	10-adrig 10-lead	DIA-601126.3 DIA-601126.2 DIA-601126.1	4 mm Banane Klammer / Clip Druckknopf / Snap	
ChoiceMMed	OBSERVER MD100A OBSERVER MD100B OBSERVER MD100E	3-adrig 3.lead	DIA-10015	Druckknopf / Snap	
Contec	1 / 3 / 6 / 12 Kanal EKG 1 / 3 / 6 / 12 Channel ECG ECG 100G / 300G / 600G, 1200G, 1212G Handheld Touch, ECG 90	10-adrig 10-lead	DIA-601126.3 DIA-601126.2 DIA-601126.1		

Diagnose – EKG – 10 adrige EKG-Komplettkabel Diagnostic – ECG – 10 lead ECG complete cable

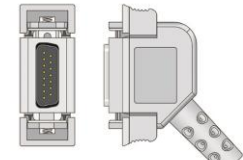
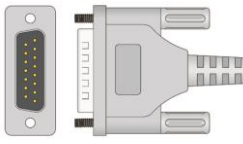
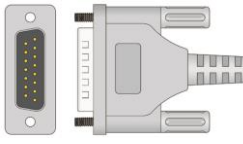
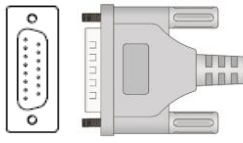
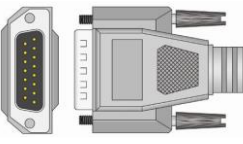

Hersteller Manufacturer	EKG-Gerätetyp ECG Device Type	Leitungen Leads	Komplettkabel Complete Cable Art.Nr. - REF	Stecker plug	Geräte-Stecker Device Connector
Creative	EASY PC-80B	3-adrig 3-lead	DIA-10023	Druckknopf / Snap	
Custo-med	Custo-Card	10-adrig 10-lead	DIA-401060.3 DIA-401060.2 DIA-401060.1	4 mm Banane Klammer / Clip Druckknopf / Snap	
Custo-med	Custo-Norm	10-adrig 10-lead	DIA-601126.3 DIA-601126.2 DIA-601126.1	4 mm Banane Klammer / Clip Druckknopf / Snap	
Dr. Gerhard Schmidt	SmartScript PC-EKG SmartScript PC-ECG	10-adrig 10-lead	DIA-701288.3 DIA-701288.2 DIA-701288.1	4 mm Banane Klammer / Clip Druckknopf / Snap	
Dr. Vetter	PC-EKG PC-ECG	10-adrig 10-lead	DIA-601125.3 DIA-601125.2 DIA-601125.1	4 mm Banane Klammer / Clip Druckknopf / Snap	
EDAN	ECG / EKG SE-1010, SE-601-Series, SE-12-EXPRESS, SE-12, SE-1200-EXPRESS, SE-1, SE-3 Series, ST-1212, SE-1515 PC-EKG REF MS1-106902	10-adrig 10-lead	DIA-701288.3 DIA-701288.2 DIA-701288.1	4 mm Banane Klammer / Clip Druckknopf / Snap	

Diagnose – EKG – 10 adrige EKG-Komplettkabel Diagnostic – ECG – 10 lead ECG complete cable



Hersteller Manufacturer	EKG-Gerätetyp ECG Device Type	Leitungen Leads	Komplettkabel Complete Cable Art.Nr. - REF	Stecker plug	Geräte-Stecker Device Connector
Ellettronica Trentina / Cardiette	Cardio Rapid K3 Serie Cardio Rapid series	10-adrig 10-lead	DIA-401060.3 DIA-401060.2 DIA-401060.1	4 mm Banane Klammer / Clip Druckknopf / Snap	
Ellettronica Trentina / Cardiette	alle / all Excel Typwen / types Excel, 101, 103, 106 Cardiorapid K-131, Autoruler 12/1, 12/3 Microruler 12/1, 12/3, Microtel	10-adrig 10-lead	DIA-601126.3 DIA-601126.2 DIA-601126.1	4 mm Banane Klammer / Clip Druckknopf / Snap	
Ellettronica Trentina / Cardiette	Alle / all ARV-/ ADV- Typen / types AR 1200, AR 1200 ADV, Start 100, 100H, 200, 200HV	10-adrig 10-lead	DIA-601126.3 DIA-601126.2 DIA-601126.1	4 mm Banane Klammer / Clip Druckknopf / Snap	
Esaote Biomedica	P80, P 80 white, P 80 mPower, P120	10-adrig 10-lead	DIA-601126.3 DIA-601126.2 DIA-601126.1	4 mm Banane Klammer / Clip Druckknopf / Snap	
FD MEDICAL	FCE-2000 PC-EKG	10-adrig 10-lead	DIA-191126.3 DIA-191126.2 DIA-191126.1	4 mm Banane Klammer / Clip Druckknopf / Snap	
Fukuda Denshi	FCP 11/ FX 101, MCP 302, FX 2111, FX 7402, FX 4010, FCP 2155	10-adrig 10-lead	DIA-701285.3 DIA-701285.2 DIA-701285.1	4 mm Banane Klammer / Clip Druckknopf / Snap	

Diagnose – EKG – 10 adrige EKG-Komplettkabel

Diagnostic – ECG – 10 lead ECG complete cable

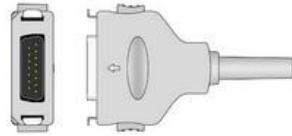
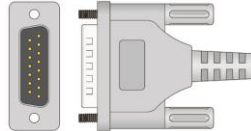
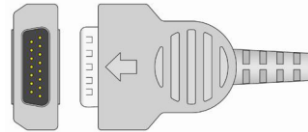
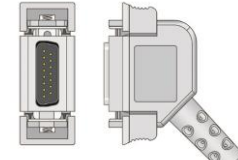
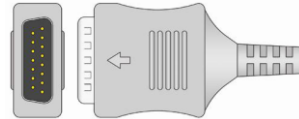
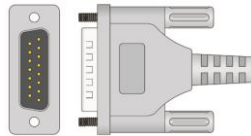

Hersteller Manufacturer	EKG-Gerätetyp ECG Device Type	Leitungen Leads	Komplettkabel Complete Cable Art.Nr. - REF	Stecker plug	Geräte-Stecker Device Connector
Fukuda Denshi	Cardiomax FX-3010, FX-7202, FX-7302, FX-7102, FX-8200 FCP-2201, FCP 2201G, FX101, FX102F, FX 328U, Alpha 500, 501 AX, Alpha 600	10-adrig 10-lead	DIA-101817.3 DIA-101817.2 DIA-101817.1	4 mm Banane Klammer / Clip Druckknopf / Snap	
Fukuda ME	Alpha 1000	10-adrig 10-lead	DIA-601126.3 DIA-601126.2 DIA-601126.1	4 mm Banane Klammer / Clip Druckknopf / Snap	
GE/ Hellige	MAC 400, MAC500, MAC 800, MAC 1100, MAC 1200, MAC 1600, MAC 2000, Microsmart	10-adrig 10-lead	DIA-101790.3 DIA-101790.2 DIA-101790.1	4 mm Banane Klammer / Clip Druckknopf / Snap	
GE / Hellige	EK 36, EK 41, EK 43, EK 53, EK 56, EK 403, EK 413, EK 512, EK 512 P, EK 512 E CardioSmard, CardioSys, Microlab	10-adrig 10-lead	DIA-401060.3 DIA-401060.2 DIA-401060.1	4 mm Banane Klammer / Clip Druckknopf / Snap	
GE / Hellige	EK 51, Corina	10-adrig 10-lead	DIA-701285.3 DIA-701285.2 DIA-701285.1	4 mm Banane Klammer / Clip Druckknopf / Snap	
heart-tec	Cardiag 12S PC-EKG	10-adrig 10-lead	DIA-601126.3 DIA-601126.2 DIA-601126.1	4 mm Banane Klammer / Clip Druckknopf / Snap	





Diagnose – EKG – 10 adrige EKG-Komplettkabel Diagnostic – ECG – 10 lead ECG complete cable



Hersteller Manufacturer	EKG-Gerätetyp ECG Device Type	Leitungen Leads	Komplettkabel Complete Cable Art.Nr. - REF	Stecker plug	Geräte-Stecker Device Connector
Hörmann / MWZ	Bioset 3500 / 3600 / 3700 / 6000 / 8000	10-adrig 10-lead	DIA-401060.3 DIA-401060.2 DIA-401060.1	4 mm Banane Klammer / Clip Druckknopf / Snap	
Hörmann / MWZ	Bioset 9000	10-adrig 10-lead	DIA-601126.3 DIA-601126.2 DIA-601126.1	4 mm Banane Klammer / Clip Druckknopf / Snap	
HP/Agilent/ PHILIPS	Pagewriter 100, 200, 200i M1770A, M1771A, M1772A Philips REFM1770A, M1771A, M1772A	10-adrig 10-lead	DIA-280273.3 DIA-280273.2 DIA-280272.1	4 mm Banane Klammer / Clip Druckknopf / Snap	
Innomed	Heart Mirror 3IUKO, Heart Screen 60G, Heart Screen 80G-L, Heart Screen 112 Visit, Heart Screen 112 Clinic, Cardio PC/E,	10-adrig 10-lead	DIA-601126.3 DIA-601126.2 DIA-601126.1	4 mm Banane Klammer / Clip Druckknopf / Snap	
KALAMED	KCE-1000 PC-EKG,	10-adrig 10-lead	DIA-191126.3 DIA-191126.2 DIA-191126.1	4 mm Banane Klammer / Clip Druckknopf / Snap	
LABTECH	PC-ECG, PC-EKG EC-12R, EC-12R/S, EC-12-RM	10-adrig 10-lead	DIA-202010.3 DIA-202010.2 DIA-202010.1	4 mm Banane Klammer / Clip Druckknopf / Snap	

Diagnose – EKG – 10 adrige EKG-Komplettkabel Diagnostic – ECG – 10 lead ECG complete cable

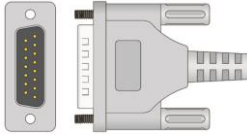
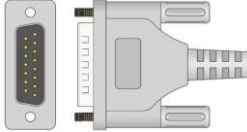

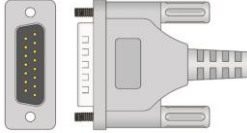
Hersteller Manufacturer	EKG-Gerätetyp ECG Device Type	Leitungen Leads	Komplettkabel Complete Cable Art.Nr. - REF	Stecker plug	Geräte-Stecker Device Connector
MINDRAY	BeneHeart R3, BeneHeart R12 (REF 040-001644-00)	10-adrig 10-lead	DIA-601126.3 DIA-601126.2 DIA-601126.1	4 mm Banane Klammer / Clip Druckknopf / Snap	
MESA	CARDIAX PC-EKG (USB) CARDIAX PC-EKG (WiFi) Standard mit 2,1 m Stammkabellänge Standard with 2,1m trunk cable length	10-adrig 10-lead	DIA-191126.3 DIA-191126.2 DIA-191126.1	4 mm Banane Klammer / Clip Druckknopf / Snap	
MESA	CARDIAX PC-EKG (WiFi) mit 1,5 m Stammkabellänge with 1,5 m trunk cable length	10-adrig 10-lead	DIA-701263.1W	Druckknopf / Snap	
MESI	mTablet ECG	10-adrig 10-lead	DIA-601126.3 DIA-601126.2 DIA-601126.1	4 mm Banane Klammer / Clip Druckknopf / Snap	
Medical Econet	Cardio M Pro EKG Cardio M, CARDIO M plus EKG Cardio XP, CARDIO E3 EKG	10-adrig 10-lead	DIA-601126.3 DIA-601126.2 DIA-601126.1	4 mm Banane Klammer / Clip Druckknopf / Snap	
Medical Econet	Cardio M PC (USB) PC-EKG Cardio M PC (WiFi) PC-EKG Standard mit 2,1 m Stammkabellänge Standard with 2,1m trunk cable length	10-adrig 10-lead	DIA-191126.3 DIA-191126.2 DIA-191126.1	4 mm Banane Klammer / Clip Druckknopf / Snap	

Diagnose – EKG – 10 adrige EKG-Komplettkabel Diagnostic – ECG – 10 lead ECG complete cable







Hersteller Manufacturer	EKG-Gerätetyp ECG Device Type	Leitungen Leads	Komplettkabel Complete Cable Art.Nr. - REF	Stecker plug	Geräte-Stecker Device Connector
Medical Econet	Cardio M PC (WiFi) PC-EKG mit 1,5 m Stammkabellänge with 1,5 m trunk cable length	10-adrig 10-lead	DIA-191126.1W	Druckknopf / Snap	
MEDSET	Flashlight	10-adrig 10-lead	DIA-191126.3 DIA-191126.2 DIA-191126.1	4 mm Banane Klammer / Clip Druckknopf / Snap	
Nihon Kohden	Cardiofax, Cardiofax Q 8110,8240,8270,8330,8340,8350,8370, 8420, 8423, 8450, 8453, 8820, 8823, 8830, ,9010K, 9020,9022,9110,9130K, 9132, 9620, PEA-1110, 1350,1250	10-adrig 10-lead	DIA-701288.3 DIA-701288.2 DIA-701288.1	4 mm Banane Klammer / Clip Druckknopf / Snap	
Nihon Kohden	Cardiofax 6353, 6151, 6851	10-adrig 10-lead	DIA-701285.3 DIA-701285.2 DIA-701285.1	4 mm Banane Klammer / Clip Druckknopf / Snap	
NORAV	1200-M, 1200-HR, 1200-HR-T, NHH-1200, 1200-S, NECG-3, NECG3+, NECG-12, NECG-12+, NECG-12c, NECG-12c+,	10-adrig 10-lead	DIA-601126.3 DIA-601126.2 DIA-601126.1	4 mm Banane Klammer / Clip Druckknopf / Snap	
Polymed	POLYCARD PC-EKG	10-adrig 10-lead	DIA-191126.3 DIA-191126.2 DIA-191126.1	4 mm Banane Klammer / Clip Druckknopf / Snap	

Diagnose – EKG – 10 adrige EKG-Komplettkabel

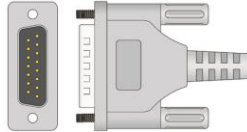

Diagnostic – ECG – 10 lead ECG complete cable

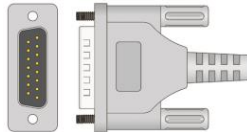

Hersteller Manufacturer	EKG-Gerätetyp ECG Device Type	Leitungen Leads	Komplettkabel Complete Cable Art.Nr. - REF	Stecker plug	Geräte-Stecker Device Connector
Reynolds / Spacelabs	Cardiotrack 12, Cardiacollect	10-adrig 10-lead	DIA-601126.3 DIA-601126.2 DIA-601126.1	4 mm Banane Klammer / Clip Druckknopf / Snap	
SCHILLER	CS-6, CS-12, CS-6/12, CS-2, AT-3, AT-5, AT-6, AT-10, CS-200 AT-10+, AT-60, AT-100, CS-200 III Schiller REF D-109114, Banana Schiller REF D 109113, Clip	10-adrig 10-lead	DIA-601126.3 DIA-601126.2 DIA-601126.1	4 mm Banane Klammer / Clip Druckknopf / Snap	
SCHILLER	AT-1, AT-2, AT-2+, AT-4, AT-101, AT-102, AR-102+, AT-104, AT-10+, AT-110, PT-160, CS-200 Excellence Schiller REF D 109011, Banana Schiller REF D 109026, Clip	10-adrig 10-lead	DIA-701322.3 DIA-701322.2 DIA-701322.1	4 mm Banane Klammer / Clip Druckknopf / Snap	
SCHILLER	MS-2007, MS-2010, MS-2015 Schiller REF D 109160, Banana Schiller REF D 109161, Clip	10-adrig 10-lead	DIA-701322.3 DIA-701322.2 DIA-701322.1	4 mm Banane Klammer / Clip Druckknopf / Snap	
SCHILLER	MS-12, FT-1 REF D 109165	10-adrig 10-lead	DIA-2310317.3 DIA-2310317.2 DIA-2310317.1	4 mm Banane Klammer / Clip Druckknopf / Snap	
SCHWARZER	Cardos 12, Cardos Light, CU 12	10-adrig 10-lead	DIA-601126.3 DIA-601126.2 DIA-601126.1	4 mm Banane Klammer / Clip Druckknopf / Snap	

Diagnose – EKG – 10 adrige EKG-Komplettkabel Diagnostic – ECG – 10 lead ECG complete cable

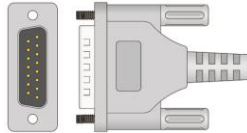
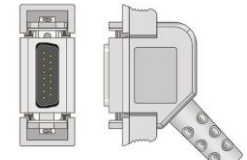
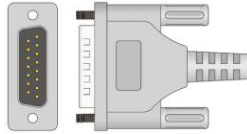
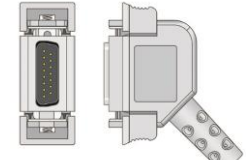

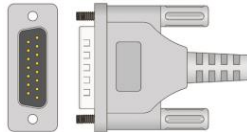
Hersteller Manufacturer	EKG-Gerätetyp ECG Device Type	Leitungen Leads	Komplettkabel Complete Cable Art.Nr. - REF	Stecker plug	Geräte-Stecker Device Connector
SPENGLER	Cardiomate PC, PC-EKG Cardiomate EKG REF 260020		DIA-601126.3 DIA-601126.2 DIA-601126.1	4 mm Banane Klammer / Clip Druckknopf / Snap	
SIEMENS	SICARD 440-740, Miracard, Mingocard, Mingophon Mingograf, Mingolog, Mingodoc Sirecard 803, Megacard CARDIOSTAT ab 33, 3T-701-703	10-adrig 10-lead	DIA-401060.3 DIA-401060.2 DIA-401060.1	4 mm Banane Klammer / Clip Druckknopf / Snap	
VITALOGRAPH®	BT-12 PC-EKG	10-adrig 10-lead	DIA-601126.3 DIA-601126.2 DIA-601126.1	4 mm Banane Klammer / Clip Druckknopf / Snap	
Welch Allyn	CardioPerfect MD PC-EKG CardioPerfect MD PC-ECG	10-adrig 10-lead	DIA-401060.3 DIA-401060.2 DIA-401060.1	4 mm Banane Klammer / Clip Druckknopf / Snap	
Welch Allyn	CardioPerfect PRO PC-ECG Ref. RE-PC-IEC-BANL Ref. RE-PC-IEC-CLIP SE-PC-IEC-PUSH	10-adrig 10-lead	DIA-701287.3 DIA-701287.2 DIA-701287.1	4 mm Banane Klammer / Clip Druckknopf / Snap	
Welch Allyn	CP50, CP 150, CP250	10-adrig 10-lead	DIA-601126.3 DIA-601126.2 DIA-601126.1	4 mm Banane Klammer / Clip Druckknopf / Snap	

Diagnose – EKG – 10 adrige EKG-Komplettkabel Diagnostic – ECG – 10 lead ECG complete cable

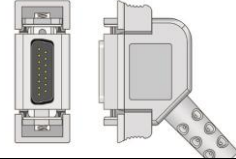
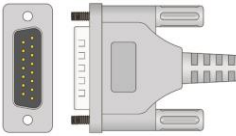

Hersteller Manufacturer	EKG-Gerätetyp ECG Device Type	Leitungen Leads	Komplettkabel Complete Cable Art.Nr. - REF	Stecker plug	Geräte-Stecker Device Connector
Zimmer Medizinsysteme	Cardio 1	10-adrig 10-lead	DIA-401060.3 DIA-401060.2 DIA-401060.1	4 mm Banane Klammer / Clip Druckknopf / Snap	
Zimmer Medizinsysteme	CardioSys, Cardio Pro, Cardio Air, Cardio Smart,	10-adrig 10-lead	DIA-601126.3 DIA-601126.2 DIA-601126.1	4 mm Banane Klammer / Clip Druckknopf / Snap	

Alle Angaben entsprechen den Kenntnissen zum Druckzeitpunkt. Änderungen aufgrund technischer Weiterentwicklung sind vorbehalten

All information is representing the technical product status at date of printing. Changes due to technical advancement are subject to modification of amendment



MESA Medizintechnik GmbH
Schärflmühlweg 4
D-83671 Benediktbeuern
Phone: +49-(0)8857-6918-0
Fax: +49-(0)8857-6918-29
Email: info@mesamed.de
Homepage: www.mesamed.de

Langzeit-EKG-Patientenkabel

Snap

AHA

2-/3-Channel

Druckknopf

2-/3-Kanal

Holter ECG patient cable

IEC

**Das Qualitätsprogramm für die MEDIZINTECHNIK
The quality program for MEDICAL TECHNOLOGY**

Rev.A12-2024

Langzeit – EKG Holter – ECG



Langzeit-EKG-Kabel – Holter ECG cable

Langzeit-EKG-Komplettkabel - Holter ECG complete cable



Langzeit-EKG-Stammkabel mit DIN-Weiche ECG Holter trunk cable with DIN yoke





DIN-EKG-Patientenleitungen – DIN ECG leadwire sets Druckknopf - Snap





Langzeit – EKG Holter – ECG



Hersteller / Manufacturer	Gerätemodell / Device model code	Typ Type	Abbildung / Picture	Komplettkabel / Complete cable Art.Nr. / REF Länge / Length	DIN-Stammkabel Trunk cable DIN yoke Art.Nr. / REF Länge / Length	DIN-Leitungen/ DIN leadwire sets Art.Nr. / REF Länge / Length
MESA	Verschiedene Hersteller mit DIN-Direktanschluss am EKG-Rekorder / Various manufacturer with DIN Yoke directly at ECG recorder	5-adrig 5-lead			verschiedene Hersteller / various manufacturers	ADD-601131 60cm ADD-801436 100cm
MESA	Verschiedene Hersteller mit DIN-Direktanschluss am EKG-Rekorder / Various manufacturers with DIN Yoke directly at ECG recorder	7-adrig 7-lead			verschiedene Hersteller / various manufacturers	ADD-601132 60cm ADD-801438 100cm
MESA LABTECH	CARDIOSPY EC-2H (IRDA –Version V4)	5-adrig 5-lead Set		LZE-701273 90 cm	nicht verfügbar / not available	nicht verfügbar / not available

Langzeit – EKG Holter – ECG



Hersteller / Manufacturer	Gerätemodell / Device model code	Typ Type	Abbildung / Picture	Komplettkabel / Complete cable Art.Nr. / REF Länge / Length	DIN-Stammkabel Trunk cable DIN yoke Art.Nr. / REF Länge / Length	DIN-Leitungen/ DIN leadwire sets Art.Nr. / REF Länge / Length
MESA LABTECH	CARDIOSPY EC-2H (BlueTooth™ Version)	5-adrig 5-lead		LZE-701281 80 cm	nicht verfügbar / not available	nicht verfügbar / not available
MESA LABTECH	CARDIOSPY EC-3H (IRDA –Version V4)	7-adrig 7-lead Set		LZE-701272 90 cm	nicht verfügbar / not available	nicht verfügbar / not available
MESA LABTECH	CARDIOSPY EC-3H (BlueTooth™ Version)	7-adrig 7-lead		LZE-701283 80 cm	nicht verfügbar / not available	nicht verfügbar / not available



Langzeit – EKG Holter – ECG



Hersteller / Manufacturer	Gerätemodell / Device model code	Typ Type	Abbildung / Picture	Komplettkabel / Complete cable Art.Nr. / REF Länge / Length	DIN-Stammkabel Trunk cable DIN yoke Art.Nr. / REF Länge / Length	DIN-Leitungen/ DIN leadwire sets Art.Nr. / REF Länge / Length
MESA LABTECH	CARDIOSPY EC-12H (BlueTooth™ Version)	10-adrig 10-lead		LZE-701287 100 cm	nicht verfügbar / not available	nicht verfügbar / not available
MESA LABTECH	CARDIOSPY EC-3H /EC-12H (BlueTooth™ Version) NEHB ECG cable, 80 cm	4-adrig 4-lead		LZE-701285 100 cm	nicht verfügbar / not available	nicht verfügbar / not available
Beneware Medical	CardioTrak ECG-Holter	5-adrig 5-lead		LZE-901801 90 cm	nicht verfügbar / not available	nicht verfügbar / not available



Langzeit – EKG Holter – ECG



Hersteller / Manufacturer	Gerätemodell / Device model code	Typ Type	Abbildung / Picture	Komplettkabel / Complete cable Art.Nr. / REF Länge / Length	DIN-Stammkabel Trunk cable DIN yoke Art.Nr. / REF Länge / Length	DIN-Leitungen/ DIN leadwire sets Art.Nr. / REF Länge / Length
Beneware Medical	CardioTrak ECG-Holter	7-adrig 7-lead		LZE-901802 90 cm	nicht verfügbar / not available	nicht verfügbar / not available
Beneware Medical	CardioTrak ECG-Holter	10-adrig 10-lead		LZE-901803 90 cm	nicht verfügbar / not available	nicht verfügbar / not available



Langzeit – EKG Holter – ECG



Hersteller / Manufacturer	Gerätemodell / Device model code	Typ Type	Abbildung / Picture	Komplettkabel / Complete cable Art.Nr. / REF Länge / Length	DIN-Stammkabel Trunk cable DIN yoke Art.Nr. / REF Länge / Length	DIN-Leitungen/ DIN leadwire sets Art.Nr. / REF Länge / Length
Biomedical Systems	BMS 300	5-adrig 5-lead		LZE-601303 90 cm	nicht verfügbar / not available	nicht verfügbar / not available
Customed	Custoport 3.Generation, R6 neu (V3) Custo Flash 100 / Custo Flash 200 / Custo Screen 200	5-adrig 5-lead		LZE-601170 150 cm	nicht verfügbar / not available	nicht verfügbar / not available



Langzeit – EKG Holter – ECG



Hersteller / Manufacturer	Gerätemodell / Device model code	Typ Type	Abbildung / Picture	Komplettkabel / Complete cable Art.Nr. / REF Länge / Length	DIN-Stammkabel Trunk cable DIN yoke Art.Nr. / REF Länge / Length	DIN-Leitungen/ DIN leadwire sets Art.Nr. / REF Länge / Length
DATRIX	VX 3+	5-adrig 5-lead		LZE-601303 90 cm	nicht verfügbar / not available	nicht verfügbar / not available
GE / Getemed	CMS 2000 / CMS 3000 / Cardio MEM	5-adrig 5-lead		LZE-601128 150cm	nicht verfügbar / not available	nicht verfügbar / not available



Langzeit – EKG Holter – ECG



Hersteller / Manufacturer	Gerätemodell / Device model code	Typ Type	Abbildung / Picture	Komplettkabel / Complete cable Art.Nr. / REF Länge / Length	DIN-Stammkabel Trunk cable DIN yoke Art.Nr. / REF Länge / Length	DIN-Leitungen/ DIN leadwire sets Art.Nr. / REF Länge / Length
Marquette Rozinn	Recorder 8500 Model 151	7-adrig 7-lead		nicht verfügbar / not available	LZE-601125 90 cm	ADD-601132 60 cm ADD-801438 100 cm
Medical ECONET	Cardio M-Holter	5-adrig 5-lead		LZE-901801 90 cm	nicht verfügbar / not available	nicht verfügbar / not available



Langzeit – EKG Holter – ECG



Hersteller / Manufacturer	Gerätemodell / Device model code	Typ Type	Abbildung / Picture	Komplettkabel / Complete cable Art.Nr. / REF Länge / Length	DIN-Stammkabel Trunk cable DIN yoke Art.Nr. / REF Länge / Length	DIN-Leitungen/ DIN leadwire sets Art.Nr. / REF Länge / Length
Medical ECONET	Cardio M Holter	7-adrig 7-lead		LZE-901802 90 cm	nicht verfügbar / not available	nicht verfügbar / not available
Medical ECONET	Cardio M Holter	10-adrig 10-lead		LZE-901803 90 cm	nicht verfügbar / not available	nicht verfügbar / not available



Langzeit – EKG Holter – ECG



Hersteller / Manufacturer	Gerätemodell / Device model code	Typ Type	Abbildung / Picture	Komplettkabel / Complete cable Art.Nr. / REF Länge / Length	DIN-Stammkabel Trunk cable DIN yoke Art.Nr. / REF Länge / Length	DIN-Leitungen/ DIN leadwire sets Art.Nr. / REF Länge / Length
Medset	Cardiolight FMC – Version E Medset REF CLR-PKF/AAZ 1599-01	5-adrig 5-lead		LZE-101729 150 cm	nicht verfügbar / not available	nicht verfügbar / not available
Reynolds	Lifecard CF kein / no Clip Reynolds REF 46-0480 (51800)	3-adrig 3-lead		LZE-601139	nicht verfügbar / not available	nicht verfügbar / not available
Reynolds	Lifecard CF mit / with Clip Reynolds REF 46-0418 (51805)	3-adrig 3-lead		LZE-601140	nicht verfügbar / not available	nicht verfügbar / not available

Langzeit – EKG Holter – ECG



Hersteller / Manufacturer	Gerätemodell / Device model code	Typ Type	Abbildung / Picture	Komplettkabel / Complete cable Art.Nr. / REF Länge / Length	DIN-Stammkabel Trunk cable DIN yoke Art.Nr. / REF Länge / Length	DIN-Leitungen/ DIN leadwire sets Art.Nr. / REF Länge / Length
Medset	Telesmart H	5-adrig 5-lead Set		LZE-101730	nicht verfügbar / not available	nicht verfügbar / not available
Schiller	medilog AR4 plus / FD5 plus / AR12 plus Schiller REF 516178 (2.400160)	5-adrig 5-lead		LZE-001668 85 cm	nicht verfügbar / not available	nicht verfügbar / not available
Schiller	MT-100 Schiller REF 145301 (2.400.092)	5-adrig 5-lead		LZE-001662 100 cm	nicht verfügbar / not available	nicht verfügbar / not available

Langzeit – EKG Holter – ECG



Hersteller / Manufacturer	Gerätemodell / Device model code	Typ Type	Abbildung / Picture	Komplettkabel / Complete cable Art.Nr. / REF Länge / Length	DIN-Stammkabel Trunk cable DIN yoke Art.Nr. / REF Länge / Length	DIN-Leitungen/ DIN leadwire sets Art.Nr. / REF Länge / Length
Schiller	MT-101 Schiller Ref 145603 (2.400103) Originalkabel	4-adrig 4-lead		LZE-001664 100 cm	nicht verfügbar / not available	nicht verfügbar / not available

Alle Angaben entsprechen den vorhandenen Kenntnissen zum Druckzeitpunkt. Änderungen aufgrund technischer Weiterentwicklung sind vorbehalten
All information is representing the technical product status at date of printing. Changes due to technical advancement are subject to modification of amendment



MESA Medizintechnik GmbH
Schärflmühlweg 4
D-83671 Benediktbeuern
Phone: +49-(0)8857-6918-0
Fax: +49-(0)8857-6918-29
Email: info@mesamed.de
Homepage: www.mesamed.de

Überwachungs-EKG - Stammkabel mit EKG-Patientenleitungen und EKG-Komplettkabel
Monitoring-ECG – Trunk cable with patient leads and complete ECG cable

Monitoring ECG

Clip

Snap

Klammer

ECG patient cable

Druckknopf

EKG-Patientenkabel

Überwachungs-EKG

IEC / AHA

Das Qualitätsprogramm für die MEDIZINTECHNIK
The quality program for MEDICAL TECHNOLOGY



Rev. A12-2024

Überwachungs-EKG-Kabel – Monitoring ECG cable

EKG-Stammkabel zum Anschluss von EKG-Patientenleitungen - ECG trunk cable for connection of ECG leadwire sets





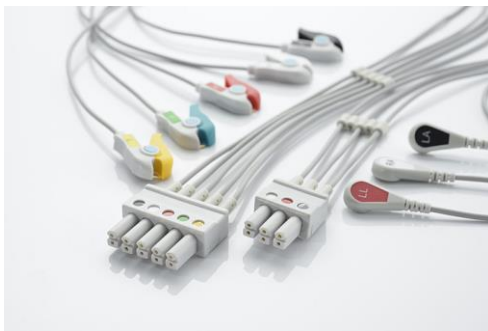

EKG-Patientenleitungen – ECG leadwire sets
Klammer oder Druckknopf / Clip or snap

EKG-Komplettkabel - ECG complete cable
Klammer oder Druckknopf / Clip or snap



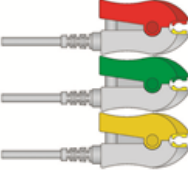

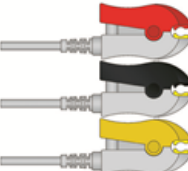

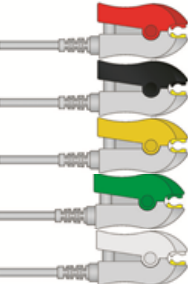

Überwachungs – EKG Monitoring – ECG



Hersteller / Manu- facturer	Gerätemodell / Device model code	Kabeltyp/ Type of cable Farbcode/ Colour code	Stammkabel-Gerätstecker/ Trunk cable – Device connector Art.Nr. – REF	Patientenleitungen- Anschluss/ Leadwire sets - Connection Art.Nr. – REF	Patientenseite/ Patient side Farben/Colours
MESA	Verschiedene Hersteller mit EKG-Stammkabel und VS-Blocksystem-Weiche / various manufacturer with ECG trunk cable and with VS system yoke	3-adrig Klammer, 3-lead clip, IEC	Verschiedene Hersteller / various manufactures	<p>ADK-101410</p>  <p>VS-System</p>	
MESA	Verschiedene Hersteller mit EKG-Stammkabel und VS-Blocksystem-Weiche / various manufacturer with ECG trunk cable and with VS system yoke	3-adrig Klammer, 3-lead clip, IEC	Verschiedene Hersteller / various manufacturers z.B. Dräger / Siemens REF M35360 / 5720030	<p>ADK-101420</p>  <p>VS-System</p>	
MESA	Verschiedene Hersteller mit EKG-Stammkabel und VS-Blocksystem-Weiche / various manufacturer with ECG trunk cable and with VS system yoke	5-adrig Klammer, 5-lead clip, IEC	Verschiedene Hersteller / various manufacturers	<p>ADK-101440</p>  <p>VS-System</p>	

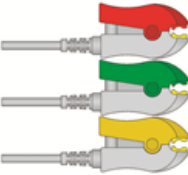

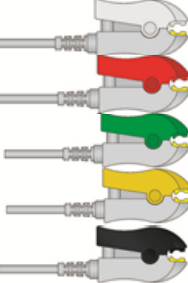

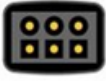
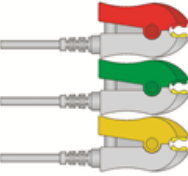

Überwachungs – EKG Monitoring – ECG

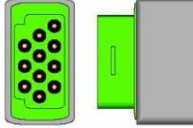

Hersteller / Manu- facturer	Gerätemodell / Device model code	Kabeltyp/ Type of cable Farbcode/ Colour code	Stammkabel-Gerätestecker/ Trunk cable – Device connector Art.Nr. – REF	Patientenleitungen- Anschluss/ Leadwire sets - Connection Art.Nr. – REF	Patientenseite/ Patient side Farben/Colours
Mindray	PM7000 / PM8000 / PM9000	3-adrig Klammer, 3-lead clip, IEC	<p>MON-141004.14</p> 	<p>ADK-150930</p>  <p>VS System</p>	
Mindray	PM7000 / PM8000 / PM9000	5-adrig Klammer, 5-lead clip, IEC	<p>MON-141005.24</p>  <p>Mindray REF 0010-3-12256</p>	<p>ADK-150950</p>  <p>VS System</p> <p>Mindray REF 0010-30-42730</p>	
GE/ Datex- Ohmeda	AS/3, CS/3, Cardiocap II, Satlite Plus S5	3-adrig, Klammer, 3-lead clip IEC	<p>MON-141001.14</p>  <p>GE / Datex REF 545300</p>	<p>ADK-150130</p>  <p>GE / Datex REF 545315</p>	

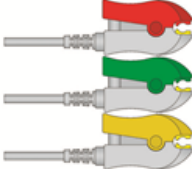

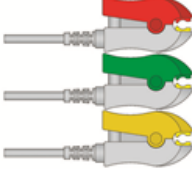

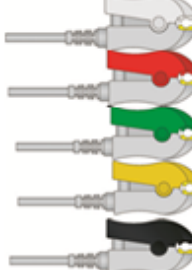



Überwachungs – EKG Monitoring – ECG

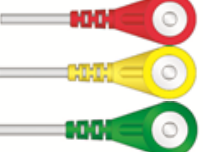

Hersteller / Manu- facturer	Gerätemodell / Device model code	Kabeltyp/ Type of cable Farbcode/ Colour code	Stammkabel-Gerätestecker/ Trunk cable – Device connector Art.Nr. – REF	Patientenleitungen- Anschluss/ Leadwire sets - Connection Art.Nr. – REF	Patientenseite/ Patient side Farben/Colours
GE/ Marquette	Eagle, Solar, Dash Monitor, MAC-Lab, Cath Lab, Datex-Ohmeda M-Prestn & “E” modules	3-adrig Klammer, 3-lead clip, IEC	MON-141002.14  GE REF 2017003-003	ADK-150330  nur 3-adrig, only 3-lead GE REF 412682-003	
HP, Agilent/ Philips	Merlin Viridia, Module: M1001B, M1002B, Multi-Parameter-Module: M3000A, M3001A, M3002A, MP2: M8102A, MP5: M8105A, C3: 862474, 862478, SureSigns Monitore: 863063, 863064, 863065, 863066, 863068, 863077, 863085, 863086, 863087, 863088 Merlin 78352C/78354C/ 78834CM1001A/ M1002A, Viridia,Ominicare CMA, ML65A,66A Heartstream Codemaster XL	3-adrig Klammer, 3-lead clip, 12-Pin, IEC	MON-801560.14  Philips REF M1510A	ADK-901530  Philips REF M1613A	
HP/Agilent/ Philips	Merlin Viridia, Module: M1001B, M1002B, Multi-Parameter-Module: M3000A, M3001A, M3002A, MP2: M8102A, MP5: M8105A, C3: 862474, 862478, SureSigns Monitore: 863063, 863064, 863065, 863066, 863068, 863077, 863085, 863086, 863087, 863088 Merlin 78352C/78354C/ 78834CM1001A/ M1002A, Viridia,Ominicare CMA, ML65A,66A Heartstream Codemaster XL	5-adrig Klammer, 5-lead clip, 12-Pin, IEC	MON-801560.24  Philips REF M1530A	ADK-901550  Philips REF M1633A	



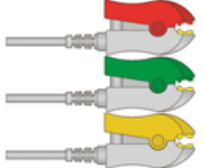

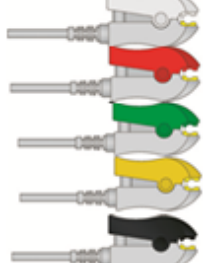

Überwachungs – EKG Monitoring – ECG



Hersteller / Manu- facturer	Gerätemodell / Device model code	Kabeltyp/ Type of cable Farbcode/ Colour code	Stammkabel-Gerätestecker/ Trunk cable – Device connector Art.Nr. – REF	Patientenleitungen- Anschluss/ Leadwire sets - Connection Art.Nr. – REF	Patientenseite/ Patient side Farben/Colours
Bionet	BM3	3-adrig Druckknopf, 3-lead snap, IEC			
Bionet	BM5	5-adrig Druckknopf, 5-lead snap, IEC		Komplettkabel Complete Cable	
HP/Agilent/ Philips	Merlin Viridia, Module: M1001B, M1002B, Multi-Parameter-Module: M3000A, M3001A, M3002A, MP2: M8102A, MP5: M8105A, C3: 862474, 862478, SureSigns Monitore: 863063, 863064, 863065, 863066, 863068, 863077, 863085, 863086, 863087, 863088 Merlin 78352C/78354C/ 78834CM1001A/ M1002A, Viridia,Ominicare CMA, ML65A,66A Heartstream Codemaster XL	3-adrig Klammer, 3-lead clip, 8-Pin, IEC	 Philips REF M1590A	 Philips REF M1613A	
HP/Agilent/ Philips	Merlin Viridia, Module: M1001B, M1002B, Multi-Parameter-Module: M3000A, M3001A, M3002A, MP2: M8102A, MP5: M8105A, C3: 862474, 862478, SureSigns Monitore: 863063, 863064, 863065, 863066, 863068, 863077, 863085, 863086, 863087, 863088 Merlin 78352C/78354C/ 78834CM1001A/ M1002A, Viridia,Ominicare CMA, ML65A,66A Heartstream Codemaster XL	5-adrig Klammer, 5-lead clip, 8-Pin, IEC	 Philips REF M1610A	 Philips REF M1633A	

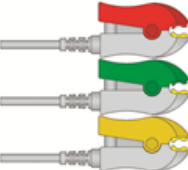

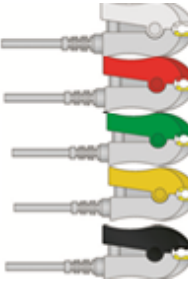

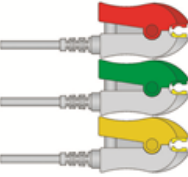

Überwachungs – EKG Monitoring – ECG



Hersteller / Manu- facturer	Gerätemodell / Device model code	Kabeltyp/ Type of cable Farbcode/ Colour code	Stammkabel-Gerätestecker/ Trunk cable – Device connector Art.Nr. – REF	Patientenleitungen- Anschluss/ Leadwire sets - Connection Art.Nr. – REF	Patientenseite/ Patient side Farben/Colours
Philips	Merlin Viridia, Module: M1001B, M1002B, Multi-Parameter-Module: M3000A, M3001A, M3002A, MP2: M8102A, MP5: M8105A, C3: 862474, 862478, SureSigns Monitore: 863063, 863064, 863065, 863066, 863068, 863077, 863085, 863086, 863087, 863088 Merlin 78352C/78354C/ 78834CM1001A/ M1002A, Viridia,Ominicare CMA, ML65A,66A Heartstream Codemaster XL, Intellivue	3-adrig Klammer, 3-lead, clip, 12-Pin, IEC	 Philips REF M1669A	 Philips REF M1672A PHI-M1678A (Original-Leitungen mit HF-Filter/ Original leadwires with HF filter)	
Philips	Merlin Viridia, Module: M1001B, M1002B, Multi-Parameter-Module: M3000A, M3001A, M3002A, MP2: M8102A, MP5: M8105A, C3: 862474, 862478, SureSigns Monitore: 863063, 863064, 863065, 863066, 863068, 863077, 863085, 863086, 863087, 863088 Merlin 78352C/78354C/ 78834CM1001A/ M1002A, Viridia,Ominicare CMA, ML65A,66A Heartstream Codemaster XL, Intellivue	5-adrig Klammer, 5-lead clip, 12-Pin, IEC	 Philips REF M1668A	 Philips REF M1971A	
Philips	Merlin Viridia, Module: M1001B, M1002B, Multi-Parameter-Module: M3000A, M3001A, M3002A, MP2: M8102A, MP5: M8105A, C3: 862474, 862478, SureSigns Monitore: 863063, 863064, 863065, 863066, 863068, 863077, 863085, 863086, 863087, 863088 Merlin 78352C/78354C/ 78834CM1001A/ M1002A, Viridia,Ominicare CMA, ML65A,66A Heartstream Codemaster XL, IntelliVue	3-adrig Klammer 3-lead clip, 12-Pin, HF-Filter, IEC	 Originalkabel Philips REF 989803170171	 Philips REF M1672A	

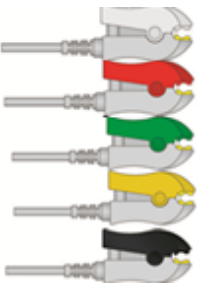

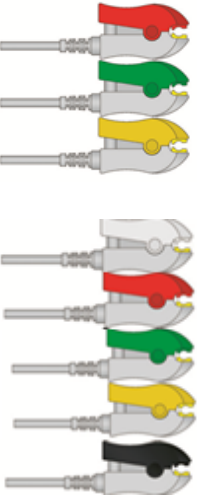

Überwachungs – EKG Monitoring – ECG



Hersteller / Manufacturer	Gerätemodell / Device model code	Kabeltyp/ Type of cable Farbcode/ Colour code	Stammkabel-Gerätestecker/ Trunk cable – Device connector Art.Nr. – REF	Patientenleitungen- Anschluss/ Leadwire sets - Connection Art.Nr. – REF	Patientenseite/ Patient side Farben/Colours
Philips	Merlin Viridia, Module: M1001B, M1002B, Multi-Parameter-Module: M3000A, M3001A, M3002A, MP2: M8102A, MP5: M8105A, C3: 862474, 862478, SureSigns Monitore: 863063, 863064, 863065, 863066, 863068, 863077, 863085, 863086, 863087, 863088 Merlin 78352C/78354C/ 78834CM1001A/ M1002A, Viridia,Ominicare CMA, ML65A,66A Heartstream Codemaster XL, IntelliVue	5-adrig Klammer 5-lead clip, 12-Pin, HF-Filter, IEC	<p style="text-align: center;">PHI-989803170181</p>  <p style="text-align: center;">Originalkabel Philips REF 989803170181</p>	<p style="text-align: center;">ADK-121550</p>  <p style="text-align: center;">Philips REF M1971A</p>	
Philips	<p style="text-align: center;">MX40 Serie Dieses Adapterkabel verbindet die MX40 Patientenmonitor Serie mit allen IntelliVue kompatiblen DIN EKG-Patientenleitungen und 8-poligen SpO2-Sensoren</p>	<p style="text-align: center;">3-adrig Klammer, 3-lead clip, IEC</p> <p style="text-align: center;">5-adrig Klammer 5-lead clip, IEC</p>	 <p style="text-align: center;">Nicht lieferbar / Not available</p>	<p style="text-align: center;">ADK-121530</p>  <p style="text-align: center;">Philips REF M1672A</p> <p style="text-align: center;">ADK-121550</p>  <p style="text-align: center;">Philips REF M1971A</p>	

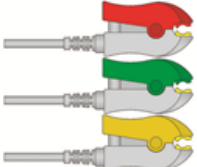

Überwachungs – EKG Monitoring – ECG

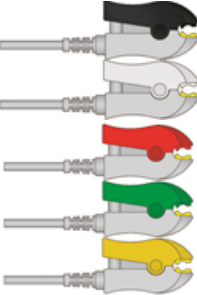

Hersteller / Manu- facturer	Gerätemodell / Device model code	Kabeltyp/ Type of cable Farbcode/ Colour code	Stammkabel-Gerätestecker/ Trunk cable – Device connector Art.Nr. – REF	Patientenleitungen- Anschluss/ Leadwire sets - Connection Art.Nr. – REF	Patientenseite/ Patient side Farben/Colours
Dräger/ Siemens	Siemens Multimed: SC 5000 / 6000 / 6000P/ 6002/ 7000/ 8000/ 9000 Dräger Infinity: Gamma / Gamma XL/ Gamma X XL/ Delta / Delta XL/ Kappa/ Kappa XLT/ Vista/Vista XL	5er Block auf 3-adrig, Klammer 3-lead to 5-lead block, clip, IEC, dual pin	<p>MON-801530</p>  <p>Dräger REF 3368391</p>	<p>ADK-101430</p>  <p>Dräger REF MP03411</p>	
Dräger/ Siemens	Siemens Multimed: SC 5000 / 6000 / 6000P/ 6002/ 7000/ 8000/ 9000 Dräger Infinity: Gamma / Gamma XL/ Gamma X XL/ Delta / Delta XL/ Kappa/ Kappa XLT/ Vista/Vista XL	5-adrig Klammer, 5-lead clip, IEC, dual pin	<p>MON-801530</p>  <p>Dräger REF 3368391</p>	<p>ADK-101450</p>  <p>Dräger REF MP03413</p>	



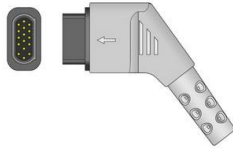

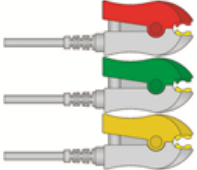

Überwachungs – EKG Monitoring – ECG

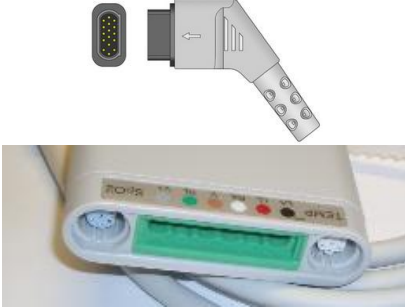

Hersteller / Manu- facturer	Gerätemodell / Device model code	Kabeltyp/ Type of cable Farbcode/ Colour code	Stammkabel-Gerätestecker/ Trunk cable – Device connector Art.Nr. – REF	Patientenleitungen- Anschluss/ Leadwire sets - Connection Art.Nr. – REF	Patientenseite/ Patient side Farben/Colours
Dräger / Siemens	Alle Multimed Pod Kabel-Systeme / dual pin All Multimed Pod cable systems / dual pin	HF-Block, dual pin	<p>DRÄ-5947226</p>  <p>Original</p>	<p>ADK-101430 ADK-101450</p>	
Dräger / Siemens	Siemens Multimed: SC 5000 / 6000 / 6000P/ 6002/ 7000/ 8000/ 9000 Dräger Infinity: Gamma / Gamma XL/ Gamma X XL/ Delta / Delta XL/ Kappa/ Kappa XLT/ Vista/Vista XL	5er Block auf 3-adrig, Klammer, 3-lead clip onto 5-lead block, HF-Filter, IEC, single pin	<p>MON-801540</p>   <p>Dräger REF MS20093</p>	<p>ADK-101530</p>  <p>Dräger REF REF MP03401</p>	

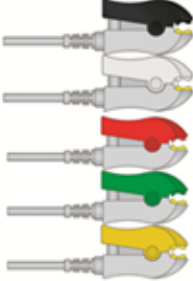

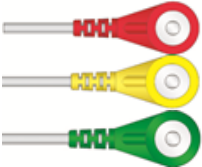



Überwachungs – EKG Monitoring – ECG

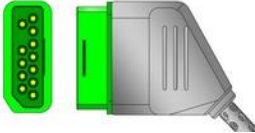

Hersteller / Manu- facturer	Gerätemodell / Device model code	Kabeltyp/ Type of cable Farbcode/ Colour code	Stammkabel-Gerätestecker/ Trunk cable – Device connector Art.Nr. – REF MON-801540	Patientenleitungen- Anschluss/ Leadwire sets - Connection Art.Nr. – REF ADK-101550	Patientenseite/ Patient side Farben/Colours
Dräger / Siemens	Siemens Multimed: SC 5000 / 6000 / 6000P/ 6002/ 7000/ 8000/ 9000 Dräger Infinity: Gamma / Gamma XL/ Gamma X XL/ Delta / Delta XL/ Kappa/ Kappa XLT/ Vista/Vista XL	5-adrig Klammer, 5-lead clip, HF-Filter, IEC, single pin	 <p>Dräger REF MS20093</p>	 <p>Dräger REF MP03403</p>	
Medical Econet	Compact 5	3-adrig Klammer, 3-lead snap, IEC	<p>MON-150010.14</p> 	<p>ADK-150020</p> 	
Medical Econet	Compact 7 / Compact 9	5-adrig Klammer, 5-lead snap, IEC	<p>MON-150030.251</p> 	<p>Komplettkabel Complete cable</p>	

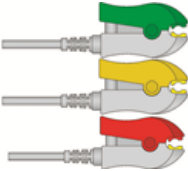
Überwachungs – EKG Monitoring – ECG

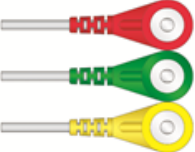

Hersteller / Manu- facturer	Gerätemodell / Device model code	Kabeltyp/ Type of cable Farbcode/ Colour code	Stammkabel-Gerätestecker/ Trunk cable – Device connector Art.Nr. – REF	Patientenleitungen- Anschluss/ Leadwire sets - Connection Art.Nr. – REF	Patientenseite/ Patient side Farben/Colours
Nihon Kohden	Life Scope I: BSM-2301 / BSM-2303 Life Scope L: BSM-2350 / BSM 2351 / BSM-4103 / BSM-4113 Life Scope A: BSM-5105 / BSM-5135 / Life Scope TR: BSM-6301 / BSM.-6501 / BSM-6701 Life Scope J: BSM-9101 Life Scope M: BSM-9510 Life Scope S: BSM-9800	4er Block auf 3-adrig Klammer, 3-lead clip onto 4-lead block, IEC	 MON-141003.24 Nihon Kohden REF K922 (JC-906P)	 ADK-150530 Nihon Kohden REF K911 (BR-903P)	
Medtronic/ Physio Control	Lifepak12 / Lifepak 20E / Lifepak 15	3-adrig Druckknopf, 3-lead snap, IEC	 MON-120110.151 Medtronic REF 11110-000030	Komplettkabel Complete Cable	
Medtronic/ Physio Control	Lifepak12 / Lifepak 20E / Lifepak 15	5-adrig Druckknopf, 5-lead snap, IEC	 MON-120110.251 Medtronic REF 11110-000067	Komplettkabel Complete Cable	

Überwachungs – EKG Monitoring – ECG



Alle Angaben entsprechen den vorhandenen Kenntnissen zum Druckzeitpunkt. Änderungen aufgrund technischer Weiterentwicklung sind vorbehalten
All information is representing the technical product status at date of printing. Changes due to technical advancement are subject to modification of amendment



MESA Medizintechnik GmbH
Schärflmühlweg 4
D-83671 Benediktbeuern

Phone: +49-(0)8857-6918-0
Fax: +49-(0)8857-6918-29
Email: info@mesamed.de
Homepage: www.mesamed.de